



Deliver an immediate smile like a PRO



T3[®] PRO

Tapered Implant





A New Generation PRO design... Built for Stability and Optimized Placement.

**Introducing T3 PRO. Stability You Can Count on,
Performance You Can Trust.**

There is nothing more symbolic of optimized placement than a trusted lighthouse in a dark sea. Guiding you with greater control and predictability, T3 PRO is engineered with a laser focus on stability. Providing a beacon of light in a situation that requires precision is the essence of ZimVie's new generation PRO design.

Stormy seas can quickly take a ship off course and into dangerous situations, whereby clarity and focus can prevent future complications for your patient's dental health. T3 PRO helps navigate a treatment plan you can trust.



You Can Depend on the T3 PRO to Deliver Immediate Smiles Like a PRO!

The T3 PRO is the next generation of the proven T3 and Osseotite® Implant. Like its predecessor, T3 PRO enables you to deliver long-term success and aesthetic outcomes. It gives you confidence to meet your patients' biggest demands: immediate function, reduced treatment times and maximum aesthetics. Take command of every clinical scenario – from routine to complex. You can depend on it like you would on a PRO.



T3 PRO Highlights

- Engineered for immediacy and high apical stability^{1,23}
- Optimized placement experience*
- Early and long-term peri-implant bone support^{11,24}
- Peri-implant defense^{6,11,25-28}
- Certain® connection compatible with SureSeal™ and platform switch technology
- Compatible with existing Certain drilling protocols, instrumentation and Restorative components

* compared to T3 Implant²³



Engineered for Immediacy and High Apical Stability

The T3 PRO features a fully tapered implant core with progressively increasing thread depth. This results in more aggressive threads which cut deeper into the bone and enable high Initial Bone-to-Implant Contact (IBIC*) especially in the apical region. This allows T3 PRO to deliver high apical stability.

With adequate primary stability and appropriate occlusal loading, the T3 PRO provides immediate function on single tooth and/or multiple teeth applications.



Implant A

High bone-to-implant surface contact
High apical engagement



Cross-section of T3 PRO (A) alongside a comparable bone level implant (B) in a dense bone-block (both implants placed following manufacturers' drilling protocol).



Implant B

Low bone to implant surface contact
Low apical engagement

* IBIC is the surface area of the implant in contact with bone at the time of placement before the new bone formation starts.^{1,23}

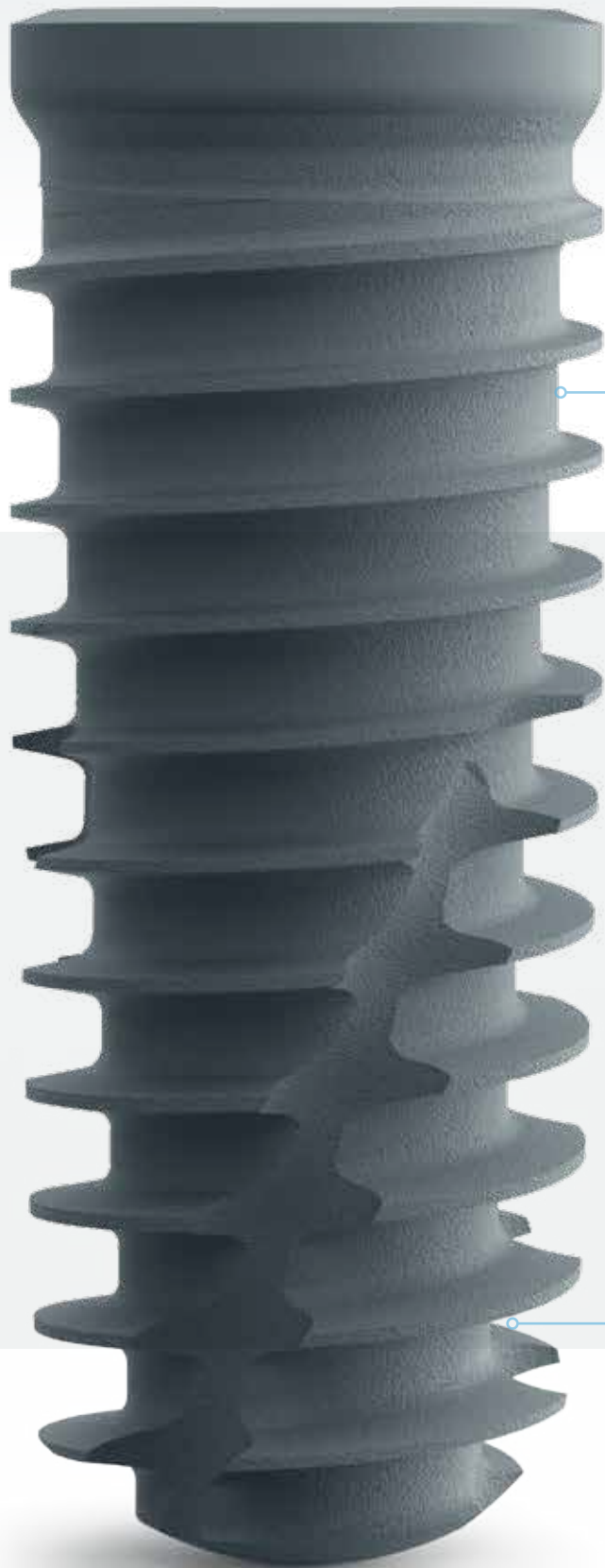

FULLY TAPERED CORE

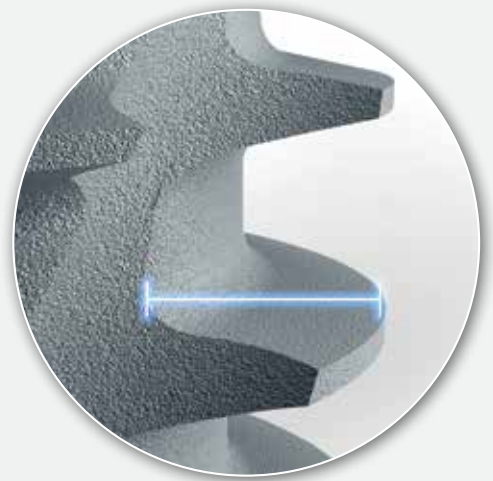

INCREASED THREAD DEPTH*

* compared to T3 Implant²³

Optimized Placement Experience

The T3 PRO features a redesigned collar, fully tapered implant core and sharp flutes for an optimized placement experience:

- Excellent cutting efficiency and improved tactile feel during placement*
- Self-tapping thread design for controlled insertion
- Ideal torque profile: Lower insertion torque gradually leading to a higher seating torque²³
- Placement depth adjustment without needing to re-prepare the site²³

ERGONOMIC COLLAR DESIGN

Placement depth adjustment





**PROGRESSIVELY
INCREASING
THREAD DEPTH**

Controlled insertion

SHARP FLUTES

Sharp cutting flutes for
increased cutting efficiency and
tactile feel during placement

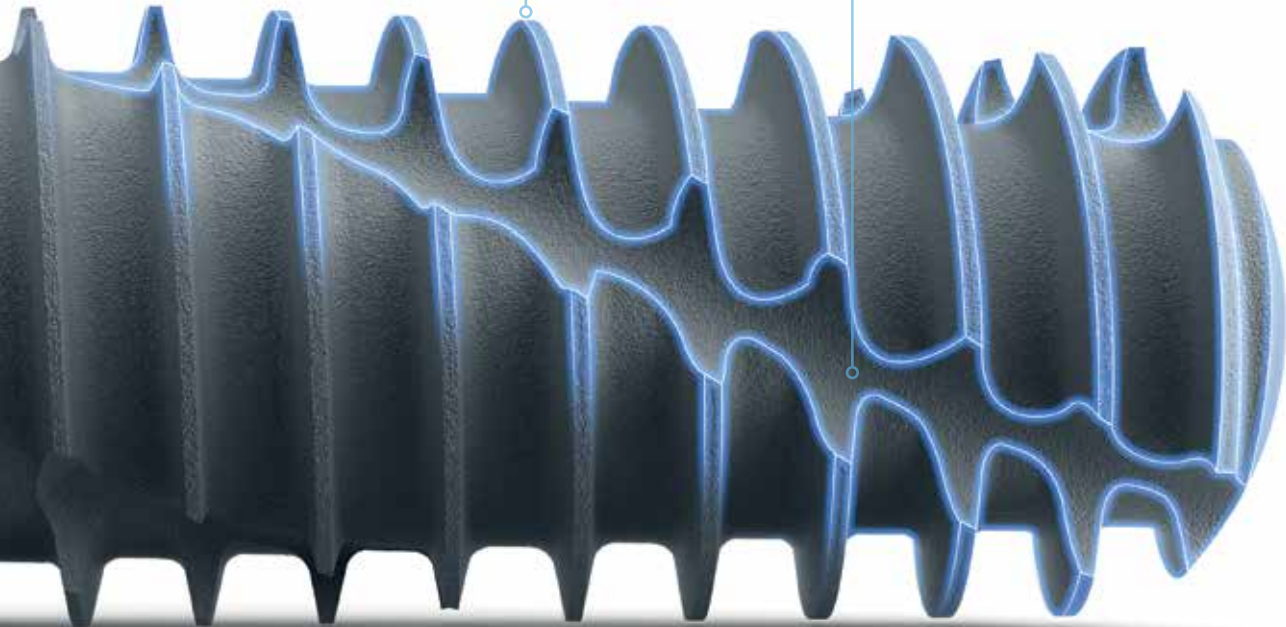

* compared to T3 Implant²³

Early and Long Term Peri-implant Bone Support

The T3 PRO utilizes the proprietary Osseotite surface technology in combination with coarse-micron features. The Osseotite surface technology consists of fine-micron features (1 to 3 microns) along the full length of the implant, created by a dual acid-etching (DAE) process. These features are analogous in size and shape to a single resorption pit created by osteoclasts.² The pits created by acid-etching have been shown to support retention of the early bone matrix and different stages of osteoconduction process, including the promotion of fibrin blood clot retention and modulation of platelet activity.^{3,4}

The T3 PRO Implant body has coarse-micron features (>10 microns), which are superimposed with the fine-micron (1 to 3 microns) dual acid-etching features. The collagen bone matrix, expressed by osteogenic cells, has been shown to wrap around these coarse-micron features and provide long-term support to mature bone matrix.⁵

Coarse micron-scale features of the implant surface. Collagen fibers are wrapping around the three-dimensional topographical features of this surface.

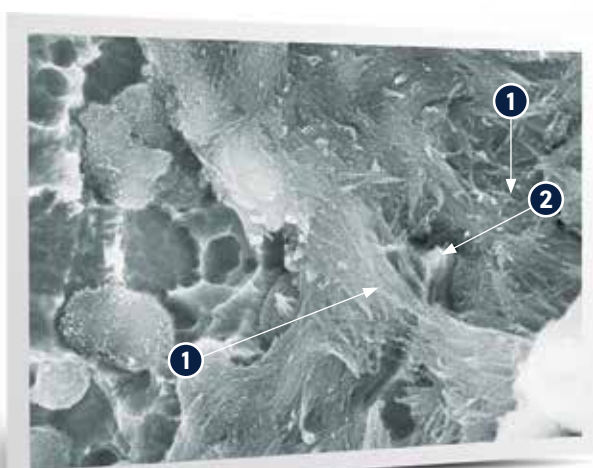

- 1 Collagen fibers wrapped around coarse structures
- 2 Tip of coarse-micron structure

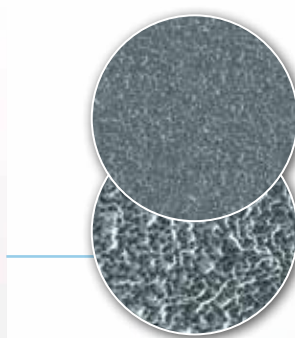

IMPLANT BODY

Coarse-micron features (> 10 microns) with fine-micron features on top



Benefits at a Glance

- Contemporary hybrid (coarse and fine) surface topography
- Surface shown to facilitate the osseointegration process¹¹
- Fine-micron surface shown to facilitate the retention of early bone matrix^{5,28}
- Coarse-micron surface shown to provide long-term support to mature bone matrix^{5,28}

The fine-micron scale structures in the implant surface support retention of early bone matrix.

3 Fine-micron structures

4 Early bone matrix

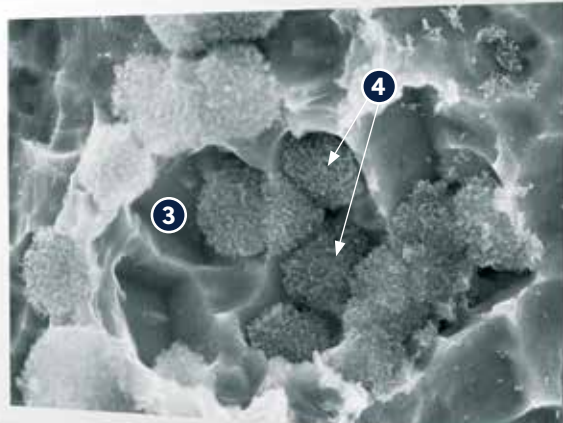

IMPLANT COLLAR
Fine-micron (1 to 3 microns)
dual acid-etching features

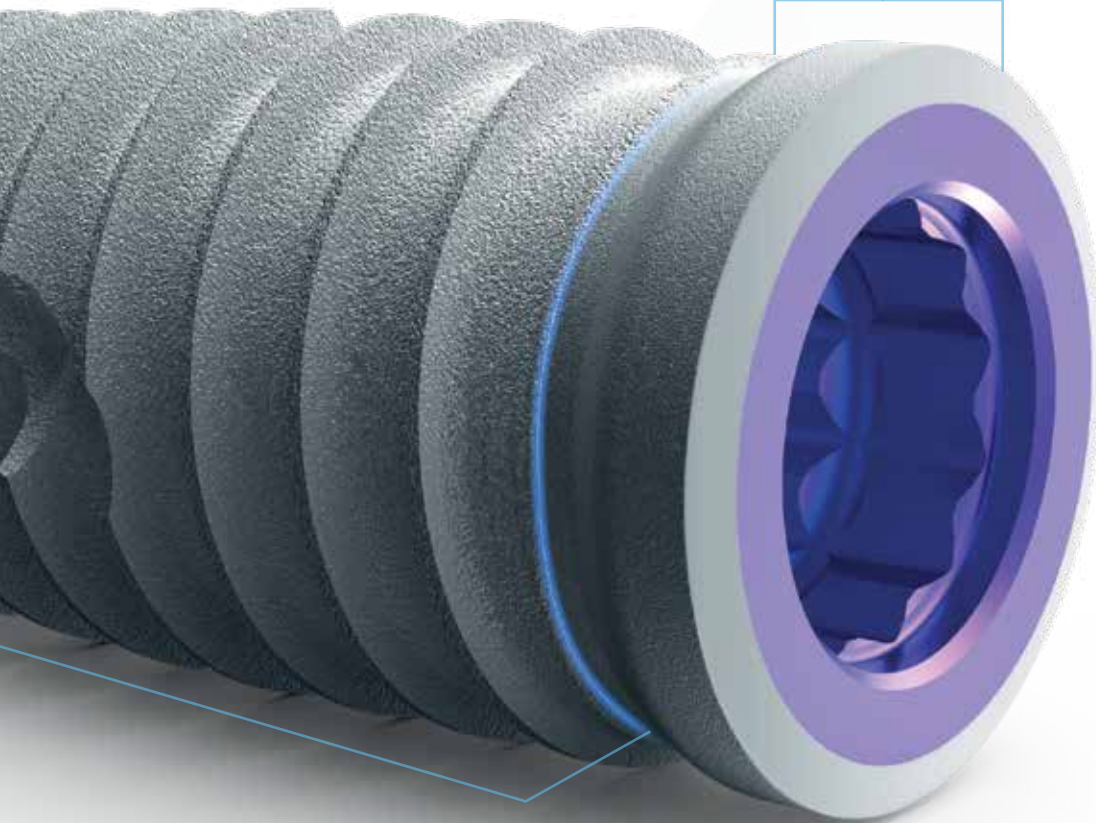

Peri-implant Defense

The T3 PRO utilizes the proprietary Osseotite surface (Dual Acid Etched surface) technology at the coronal aspect of the implant. Long-term results show the Osseotite surface presents no higher risk of peri-implantitis than machined titanium while supporting healthy bone level maintenance.⁶

Numerous global multi-center clinical studies have documented successful outcomes using implants with the Osseotite surface technology.⁷⁻¹² Human histologic analysis has shown a high bone to implant contact for Osseotite surface when compared to machined surface.¹³ Clinical studies on the Osseotite surface continue to document the benefits of increased contact osteogenesis, especially in poor quality bone.¹⁴



Benefits at a Glance

- No higher risk of peri-implantitis than machined titanium while supporting healthy bone level maintenance⁶
- Osseotite surface has shown high bone-to-implant contact compared to machined surface¹³

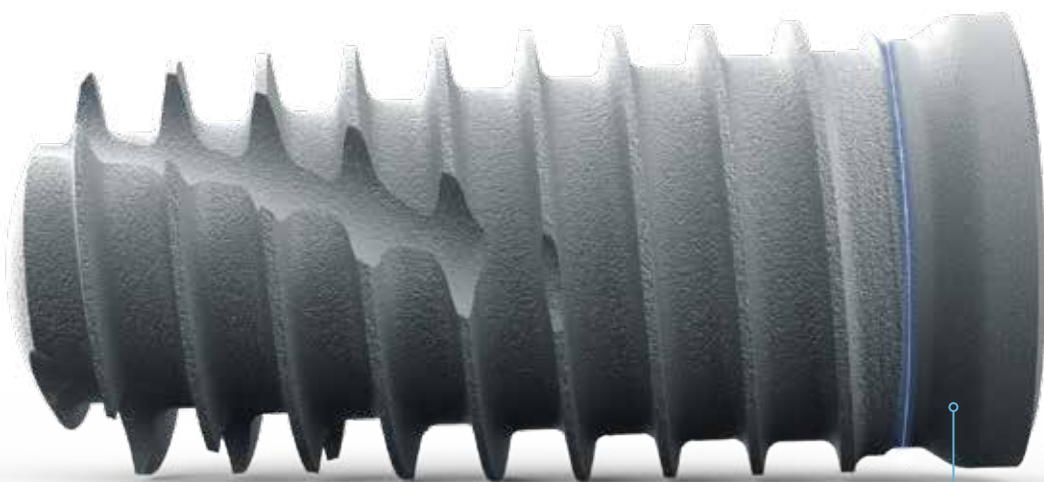

Osseotite surface technology in the coronal part of the implant helps maintain the bone level without increasing the risk of peri-implantitis.⁶

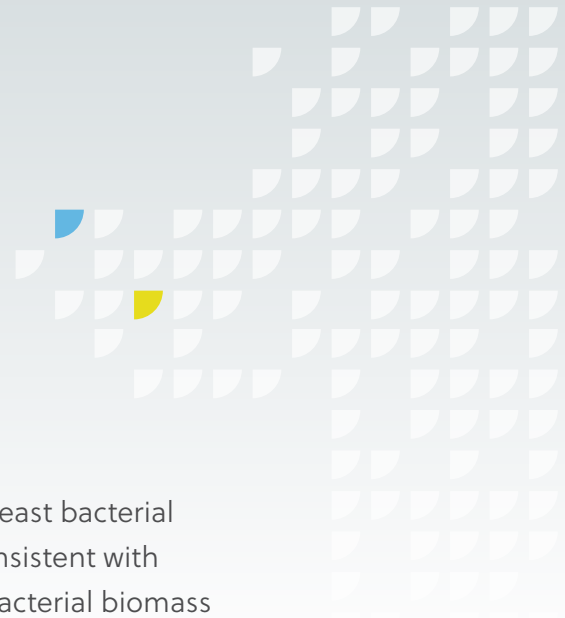

An in-vitro study showed that the Osseotite surface had the least bacterial adhesion of roughened surfaces tested.¹⁵ This finding was consistent with other research studies that reported more accumulation of bacterial biomass and/or significant higher number of pathogenic bacteria on moderate roughness surfaces (Sa: 1.1–2.0 μm) when compared to minimal roughness surfaces (Sa: 0.5–1.0 μm).^{16,17} Low bacterial adhesion may help minimize bacterial colonization and biofilm formation, factors that may lower the risk of peri-implantitis.¹⁸

Bacterial adhesion on machined and other textured surfaces²³

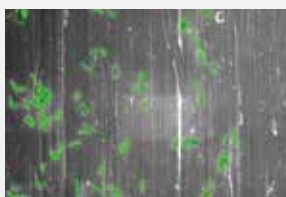

Machined CP Ti

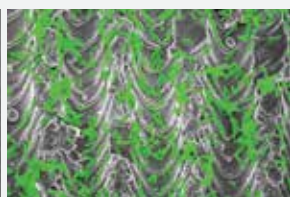

Laser-Lok[®]



SLA[®]

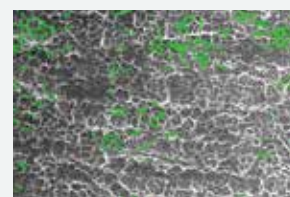

Osseotite (DAE)

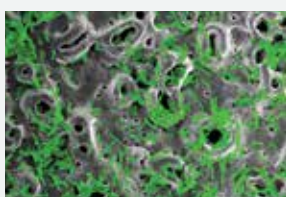

TiUnite[®]

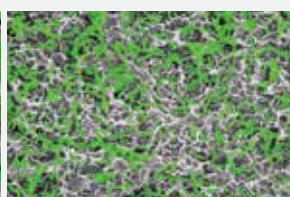

Acqua[™]



OsseoSpeed[®]

Bacterial adhesion on Osseotite surface

While Osseotite surface shows similar bacterial adhesion to the machined titanium surface, long-term data show less crestal bone loss with the implants with Osseotite than machined surface on the collar.⁶

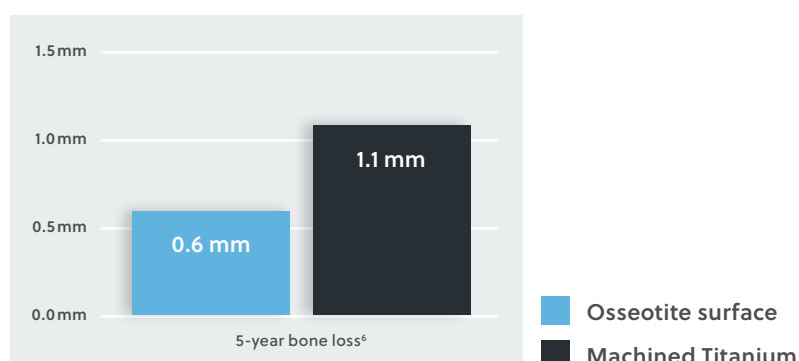

Certain Connection Compatible with SureSeal and Platform Switch Technology

High Seal Strength Between Implant and Abutment

The foundation of T3 PRO remains the unique Certain connection compatible with SureSeal technology which ensures a stable and tight implant/abutment interface, thus minimizing abutment micromotion and potential microleakage.²¹



Scan To See How Certain Connection Compares To Other Connections
<https://vimeo.com/657881435>

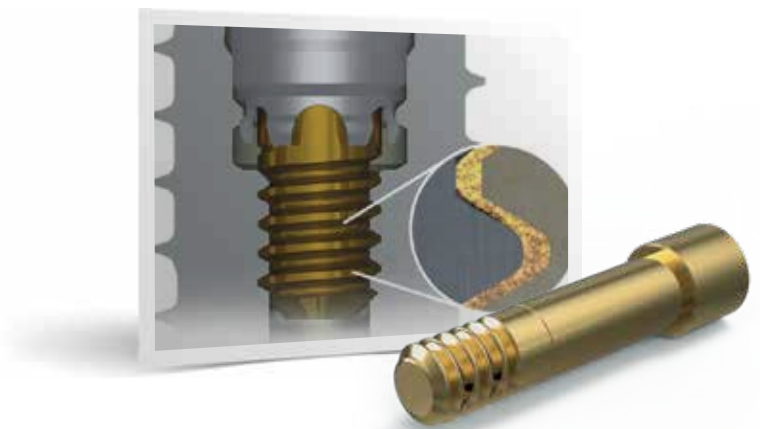

Better Seal Integrity than Conical and Other Flat-on-Flat Connections²³

An independently executed gas-enhanced permeation test (GEPT) study performed at University of Zurich showed Certain connection to have the best sealing against gas, saline and bacteria amongst other flat-on-flat and conical connections.²²

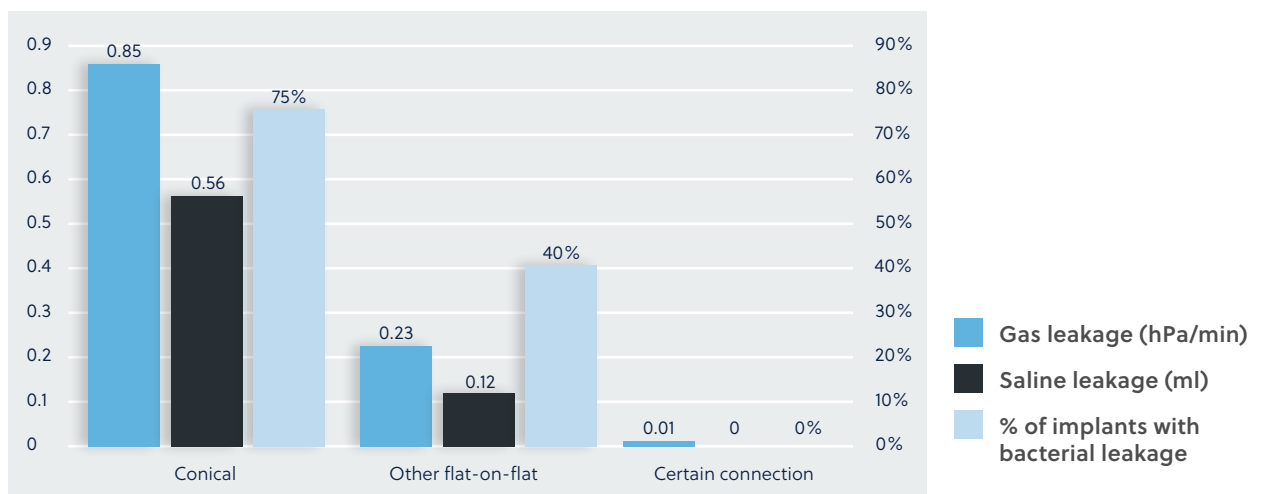

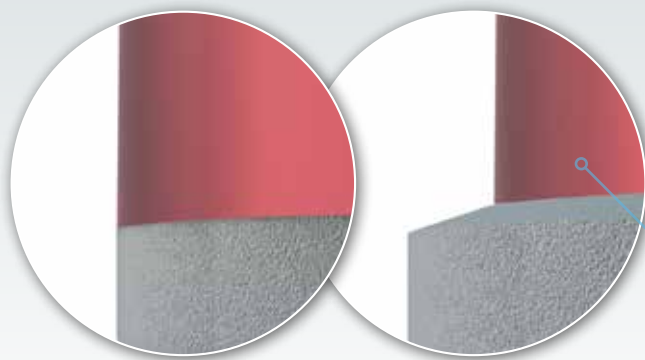

Non-platform switched

Platform switched

Proven Strategy to Maintain Bone Levels: Integrated Platform Switching

T3 PRO implants are available with a coronal platform-switching feature. In platform-switched T3 PRO, the outer edge of the implant-abutment interface is repositioned inwardly and away from the outer edge of the implant platform. The resulting medialized implant-abutment junction provides support for connective tissue and reduces crestal bone loss.¹⁹ Long-term radiographic follow-up of these platform-switched dental implants have demonstrated 50% reduction in crestal bone loss vs non-platform-switched implants.²⁰

T3 PRO platform-switched implants are available in following sizes: 4D/3P mm, 5D/4P mm, 6D/5P mm

D = Implant body diameter

P = Diameter of prosthetic platform



Benefits at a Glance

- Reduced crestal bone loss
- Provides support for connective tissue

T3 PRO's platform is compatible with Encode® Emergence which further provides hard- and soft-tissue maintenance

Compatible with Existing Certain Tapered Drilling Protocols and Restorative Components

The T3 PRO features the Certain connection which offers a broad option of restorative components, from provisionals, to single-unit cement or screw-retained, stock or digital workflow, to removable or fixed hybrid full-arch. The T3 PRO is also compatible with existing Certain Surgical Instrumentation and Navigator® guided surgery systems.

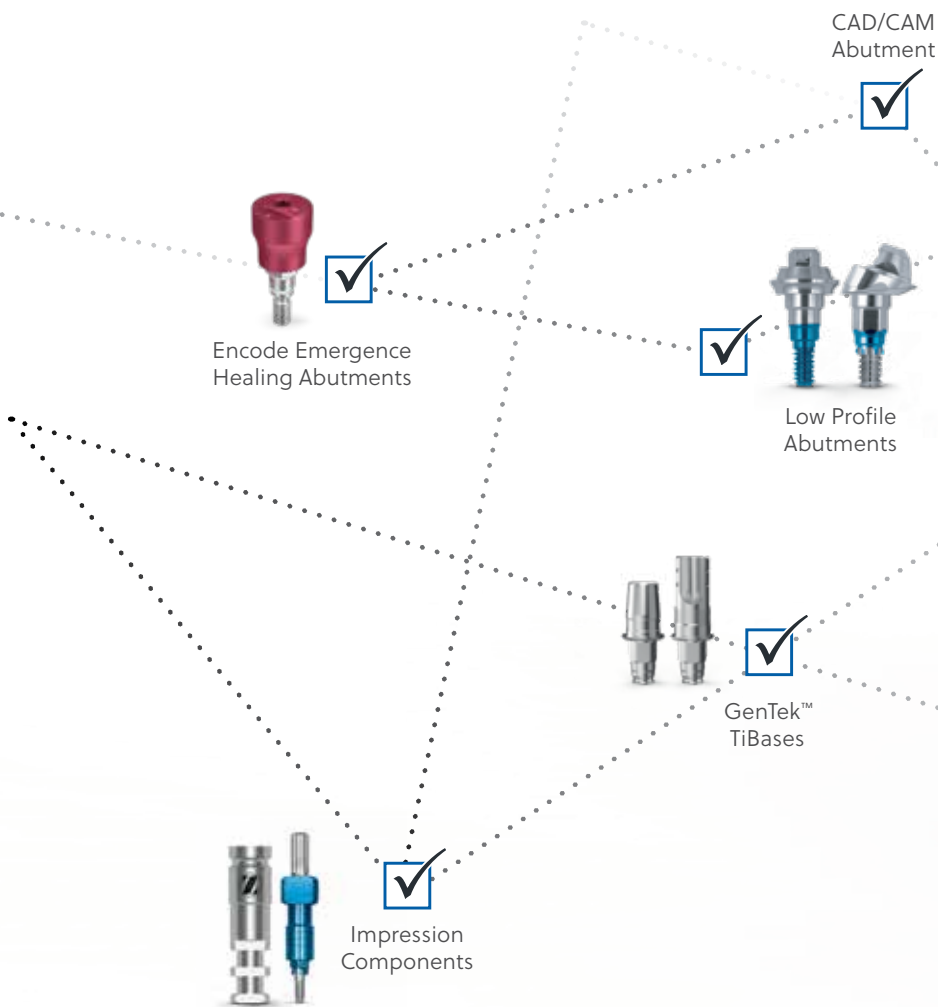

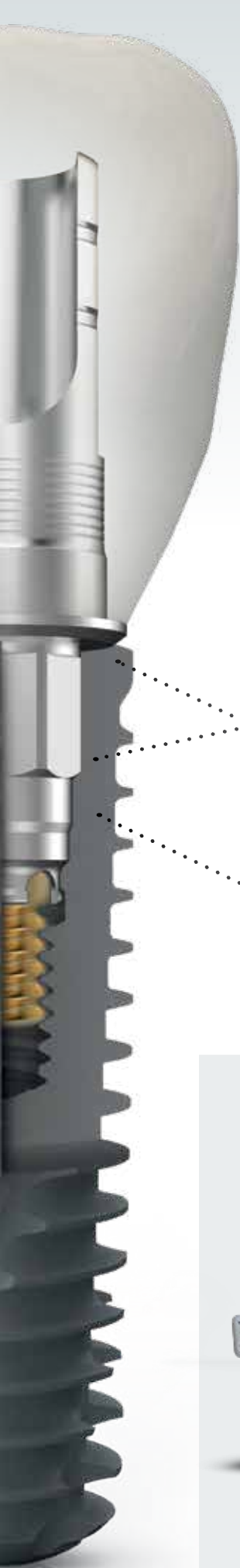

Provisional Restorations



OverdenSURE® Removable Attachment System



Full Arch Rehabilitation Protocols



Certain Surgical Instrumentation and Navigator guided surgery systems



Navigator Guided Surgery Kit



Surgical Kit



Surgical Instrumentation

Your Path of Digital Dentistry

ZimVie's suite of digital solutions allows you to flexibly choose your course to a precisely positioned, esthetically restored T3 PRO. It consists of diverse solutions for surgical planning, fully guided placement and advanced design of your restorative components.

Conduct the planning and designing yourself or outsource to the laboratory of your choice or one of ZimVie's skilled partners. Decide to Go for the PRO and select your preferred customized workflow options along the way to a healthy patient smile!



SCAN

Use an iTero™ Element Plus Series intraoral scanner to improve the patient experience whenever an impression is taken.

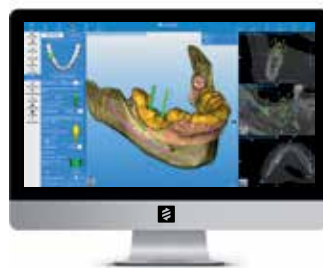

PLAN

The RealGUIDE™ Software Suite offers everything you need for precise planning and predictable implant placement.



GUIDE

Implant Concierge™ is a web-based platform that acts as your Virtual Treatment Plan Coordinator™ – the one-stop shop for your guided surgery needs.



PLACE

Take the complexity and inaccuracies out of fully guided surgery by using the Navigator System.

3-in-1
Healing Abutment,
Impression Coping,
Scanbody



HEAL AND SCAN

Naturally shape the soft-tissue and efficiently process the final restoration with the easy to use Encode Emergence Impression System.



RESTORE

Select between GenTek consumables or patient specific CAD/CAM abutments, designed to match the patient's anatomy, producing a natural emergence profile though the soft-tissue.

Ordering Information

T3 PRO Platform Switched



	Length				
	8.5 mm	10 mm	11.5 mm	13 mm	15 mm
4/3 mm P	T3PT4385	T3PT4310	T3PT4311	T3PT4313	T3PT4315
5/4 mm P	T3PT5485	T3PT5410	T3PT5411	T3PT5413	T3PT5415
6/5 mm P	T3PT6585	T3PT6510	T3PT6511	T3PT6513	T3PT6515

D = Implant body diameter

P = Diameter of prosthetic platform

T3 PRO non-Platform Switched



	Length				
	8.5 mm	10 mm	11.5 mm	13 mm	15 mm
3.25 mm D	T3ST3285	T3ST3210	T3ST3211	T3ST3213	T3ST3215
4 mm D	T3ST485	T3ST410	T3ST411	T3ST413	T3ST415
5 mm D	T3ST585	T3ST510	T3ST511	T3ST513	T3ST515
6 mm D	T3ST685	T3ST610	T3ST611	T3ST613	T3ST615

References: 1 Degidi M, Dapri G, Piattelli A, Iezzi G. Development of a new implant primary stability parameter: insertion torque revisited. *Clin Implant Dent Relat Res.* 2013 Oct;15(5):637-44. doi: 10.1111/j.1708-8208.2011.00392.x. Epub 2011 Oct 18. PMID: 22008885. 2 Davies JE, Ajami E, Moineddin R, Mendes VC. The roles of different scale ranges of surface implant topography on the stability of the bone/implant interface. *Biomaterials.* 2013 May;34(14):3535-46. doi: 10.1016/j.biomaterials.2013.01.024. Epub 2013 Feb 14. PMID: 23415644. 3 Davies JE. Understanding peri-implant endosseous healing. *J Dent Educ.* 2003 Aug;67(8):932-49. PMID: 12959168. 4 Park JY, Gemmell CH, Davies JE. Platelet interactions with titanium: modulation of platelet activity by surface topography. *Biomaterials.* 2001 Oct;22(19):2671-82. doi: 10.1016/s0142-9612(01)00009-6. PMID: 11519787. 5 Davies JE, Mendes VC, Ko JC, Ajami E. Topographic scale-range synergy at the functional bone/implant interface. *Biomaterials.* 2014 Jan;35(1):25-35. doi: 10.1016/j.biomaterials.2013.09.072. Epub 2013 Oct 4. PMID: 24099707. 6 Zetterqvist L, Feldman S, Rotter B, Vincenzi G, Wennström JL, Cherico A, Stach RM, Kenealy JN. A prospective, multicenter, randomized-controlled 5-year study of hybrid and fully etched implants for the incidence of peri-implantitis. *J Periodontol.* 2010 Apr;81(4):493-501. doi: 10.1902/jop.2009.090492. PMID: 20367092. 7 Calvo-Guirado JL, Gómez-Moreno G, Delgado-Ruiz RA, Maté Sánchez de Val JE, Negri B, Ramírez Fernández MP. Clinical and radiographic evaluation of osseointegrated platform implants related to crestal bone loss: a 10-year study. *Clin Oral Implants Res.* 2014 Mar;25(3):352-358. doi: 10.1111/clr.12134. Epub 2013 Feb 21. PMID: 23425107. 8 Schropp L, Wenzel A, Stavropoulos A. Early, delayed, or late single implant placement: 10-year results from a randomized controlled clinical trial. *Clin Oral Implants Res.* 2014 Dec;25(12):1359-65. doi: 10.1111/clr.12273. Epub 2013 Oct 8. PMID: 25040354. 9 Schropp L, Wenzel A, Spin-Neto R, Stavropoulos A. Fate of the buccal bone at implants placed early, delayed, or late after tooth extraction analyzed by cone beam CT: 10-year results from a randomized, controlled, clinical study. *Clin Oral Implants Res.* 2015 May;26(5):492-500. doi: 10.1111/clr.12424. Epub 2014 Jun 2. PMID: 24890861. 10 Schropp L, Isidor F. Papilla dimension and soft tissue level after early vs. delayed placement of single-tooth implants: 10-year results from a randomized controlled clinical trial. *Clin Oral Implants Res.* 2015 Mar;26(3):278-86. doi: 10.1111/clr.12489. Epub 2014 Sep 27. PMID: 25263735. 11 Testori, Tiziano & Galli, Fabio & Capelli, Matteo & Zuffetti, Francesco & Buti, Jacopo & Esposito, Marco. (2021). Immediate nonocclusal versus early loading of dental implants in partially edentulous patients – 15-year follow-up of a multicenter randomised controlled trial. *Clinical Trials in Dentistry.* 03. 05. 10.36130/CTD.01.2021.02. 12 Galli F, Capelli M, Zuffetti F, Testori T, Esposito M. Immediate non-occlusal vs. early loading of dental implants in partially edentulous patients: a multicenter randomized clinical trial. *Peri-implant bone and soft-tissue levels.* *Clin Oral Implants Res.* 2008 Jun;19(6):546-52. doi: 10.1111/j.1600-0501.2008.01530.x. Epub 2008 Apr 16. PMID: 18422981. 13 Lazzara RJ, Testori T, Trisi P, Porter SS, Weinstein RL. A human histologic analysis of osseointegration and machined surfaces using implants with 2 opposing surfaces. *Int J Periodontics Restorative Dent.* 1999 Apr;19(2):117-29. PMID: 10635177. 14 Testori T, Wiseman L, Woolfe S, Porter SS. A Prospective Multicenter Clinical Study of the Osseointegrated Implant: Four-Year Interim Report. *Int J Oral Maxillofac Implants.* 2001 Mar-Apr;16(2):193-200. 15 Park SJ, Sanchez O, Ajami E, Wen HB. Bacterial Adhesion to Different Dental Implant Collar Surfaces: An in-vitro comparative study. 34th Annual Meeting Academy of Osseointegration, Washington, DC, March 2019. 16 Bernejo P, Sánchez MC, Llama-Palacios A, Figuero E, Herrera D, Sanz Alonso M. Biofilm formation on dental implants with different surface micro-topography: An in vitro study. *Clinical Oral Implants Research.* 2019 Aug;30(8):725-34. 17 Schmidlin PR, Müller P, Attin T, Wieland M, Hofer D, Guggenheim B. Polyspecies biofilm formation on implant surfaces with different surface characteristics. *Journal of Applied Oral Science.* 2013 Jan;21:48-55. 18 Subramani et al. Biofilm on dental implants: a review of the literature. *Int J Oral Maxillofac Implants.* 2009; 24(4):616-26. 19 Lazzara RJ, Porter SS. Platform switching: A new concept in implant dentistry for controlling postrestorative crestal bone levels. *Int J Perio Rest Dent.* 2006;26:9-17. 20 Boitel N, Andreoni C, Grunder U, Naef R, Meyenberg K. A three year prospective, multicenter, randomized-controlled study evaluating platform switching for the preservation of peri-implant bone levels. Poster Presentation P83: Academy of Osseointegration, 26th Annual Meeting: 2011 March 3-5; Washington DC. 21 Suttin Z, Towse R, Cruz J. A novel method for assessing implant-abutment connection seal robustness. Poster Presentation (P188): Academy of Osseointegration, 27th Annual Meeting, March 2012; Phoenix, AZ. Note: The authors conducted this research while employed at Zimmer Biomet. Pre-clinical and/or bench top studies are not necessarily indicative of clinical performance. 22 Al-Jadaa A, Attin T, Peltomäki T, Schmidlin PR. Comparison of three in vitro implant leakage testing methods. *Clin Oral Implants Res.* 2015 Apr;26(4):e1-e7. doi: 10.1111/clr.12314. Epub 2013 Dec 16. PMID: 24330007. 23 Data on File by Zimmer. 24 Delucchi F, Pozzetti E, Bagnasco F, Pesce P, Baldi D, Pera F, Di Tullio N, Pera P, Menini M. Peri-Implant Tissue Behaviour Next to Different Titanium Surfaces: 16-Year Post-Trial Follow-Up. *Appl. Sci.* 2021, 11, 9625. https://doi.org/10.3390/app11209625 25 Abrahamsson N, U Zitzmann, T Berglundh, E Linder, A Wennerberg, J Lindhe. The mucosal attachment to titanium implants with different surface characteristics. *J Clin Periodontol* 2002; 29:448-454. PMID: 12060428. DOI: 10.1034/j.1600-051x.2002.290510.x 26 Nicola U Zitzmann, I Abrahamsson, T Berglundh, J Lindhe. Soft tissue reactions to plaque formations at implant abutments with different surface topography. *J Clin Periodontol* 2002;29:456-461. PMID: 12060429. DOI: 10.1034/j.1600-051x.2002.290511.x 27 Domenico Baldi, Maria Menini, Francesco Pera, Giambattista Ravera, Paolo Pera. Plaque accumulation on exposed titanium surfaces and peri-implant tissue behavior: A preliminary one-year clinical study. *Int J Prosthodont* 2009;Sep-Oct 22(4):447-455. PMID: 20095192 28 Albrektsson T, Wennerberg A. Oral implant surfaces: Part 1 – review focusing on topographic and chemical properties of different surfaces and in vivo responses to them. *Int J Prosthodont.* 2004 Sep-Oct; 17(5):536-43. PMID: 15543910



Contact us by phone at
0800 652 1233 (UK) / 1 800 552 752 (Ireland)
or visit **ZimVie.com/dental**

ZimVie Dental Global Headquarters

4555 Riverside Drive
Palm Beach Gardens, FL 33410
Phone: +1-561-776-6700
Fax: +1-561-776-1272
dentalCS@ZimVie.com

Biomet 3i (UK & Ireland) Ltd

Reading Business Centre
Suite 807, 8th Floor Fountain House
2 Queens Walk, Reading, Berks
RG1 7QF, United Kingdom
Phone (UK): 0800 652 1233
Phone (Ireland): 1 800 552 752
ZV.UKorders@ZimVie.com



Unless otherwise indicated, as referenced herein, all trademarks and intellectual property rights are the property of ZimVie Inc. or an affiliate; and all products are manufactured by one or more of the dental subsidiaries of ZimVie Inc. (Biomet 3i, LLC, Zimmer Dental, Inc., etc.) and marketed and distributed by ZimVie Dental and its authorized marketing partners. ZimVie is an authorized distributor of iTero Products which are manufactured by Align Technology, Inc. Invisalign, iTero, iTero Element, the iTero logo, among others, are the trademarks and/or service marks of Align Technology, Inc. or one of its subsidiaries or affiliated companies and may be registered in the U.S. and/or other countries. For additional product information, please refer to the individual product labeling or instructions for use. Product clearance and availability may be limited to certain countries/regions. This material is intended for clinicians only and does not comprise medical advice or recommendations. Distribution to any other recipient is prohibited. This material may not be copied or reprinted without the express written consent of ZimVie.

